



WARNING:

CHOKING HAZARD - small parts,
Not for children under 3 years.

Basic Description of Drones

1. UA level:

The Z10 drone belongs to the C0 level toy drones, which are usually designed for entertainment and leisure activities, suitable for beginners or young aviation enthusiasts. Drones in the C0 category typically have basic flight functions and simple operating systems.

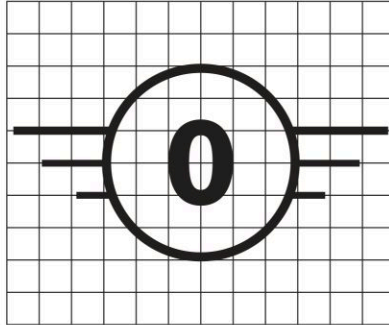

2. UA Mass and Maximum Takeoff Mass (MTOM):

The Z10 is a lightweight remote-controlled folding aircraft with a takeoff weight of 68 grams.

3. Maximum flight speed and maximum flight altitude of drones:

The maximum flight speed is 4m/s and the maximum flight altitude is 50m.

4. The general characteristics of the payload, including mass dimensions, interface with UA, and other possible limitations:

The Z10 drone does not have a payload function.

This means it cannot carry additional equipment or weight, such as cameras or other sensors.

Its design is mainly for the basic flight experience.

5. Remote control of UA devices and software control methods:

The Z10 drone uses 2.4G frequency for remote control and supports operation through the WiFi App.

This control method provides flexible operating options, allowing users to choose to use traditional remote controls or control through applications on smart devices.

6. Description of UA's behavior when data link is lost:

The maximum height that the Z10 drone can reach above the takeoff point is 50 meters.

Exceeding this altitude may cause the drone to lose control and descend, and the operator may not be able to control the drone during the descent process, which may result in the loss of the drone.

This safety feature reminds users to pay attention to altitude restrictions during flight to avoid flight risks.

7. Applicable age for drones:

This aircraft is only suitable for personnel aged 12 and above to operate.

8. Operational limitations and risks of drones:

To ensure flight safety, please try to avoid areas such as airports, highways, train stations, subway stations, and densely populated urban areas when flying; Do not use this aircraft in extreme weather conditions such as strong winds and thunderstorms. Fly within visible range at night.

9. Drone operation instructions:

Please refer to the detailed instructions in the manual for details. Please use this aircraft under the guidance of the manual.

Folding Aerial Photography Aircraft

Operating Instructions



— Portable • Fold —

● To ensure the electromagnetic environment requirements of aviation radio stations, it is prohibited to operate within a range of 10 kilometers on both sides of the airport runway centerline and 20 kilometers on both ends of the runway, as well as civil aviation routes and routes. Stop using various models and drones. Stop using various models and drones in the prohibited flight zones issued by relevant national departments.

● To ensure the electromagnetic environment requirements of aviation radio stations, it is prohibited to use various model remote controls in an area with a radius of 5000 meters centered around the center point of the airport runway. During the period when relevant national departments issue radio control orders, the use of model remote controls in the area should be stopped as required.

Directory

Preface.....	1
Warning.....	2
Safe flight guidelines.....	3
Remote control function.....	4
Product specifications.....	5
Aircraft components.....	5
Propeller installation.....	5
Battery installation/removal.....	5
Aircraft battery and remote control charging.....	6
Remote control operation method.....	7
Preparation before takeoff.....	7
[Step 1]Aircraft code matching operation guide.....	7
[Step 2]Gyroscope calibration.....	8
[Step 3]Geomagnetic correction.....	8
[Step 4]Connect wifi.....	8
[Step 5]Gps search successful.....	8
[Step 6]Motor unlocking.....	9
Mode switching.....	9
Product function analysis.....	9
A.One click takeoff/landing.....	9
B.Headless mode.....	10
C.Return flight.....	10
1.One click return.....	10
2.No signal return.....	10
3.Low power return.....	11
D.Photography/video recording.....	11
Camera angle control.....	11
Calibration of two axis pan tilt.....	12
installing a memory card.....	12
Read memory card.....	12
Basic parameter information.....	13
List of accessories.....	14
Product components - basic components.....	14
Maintenance and upkeep.....	14

Preface

You are welcome to purchase this product. In order to make it easier and more convenient for you to use this aircraft, please read this manual carefully before you operate it. At the same time, please keep this manual properly as a reference for future adjustment and maintenance.

Important statement

1. This product is not suitable for use by people under the age of 14. This product is a precision equipment that integrates professional knowledge in mechanics, electronics, aerodynamics, high-frequency emission, etc. It requires correct assembly and debugging to avoid accidents. The product holder must use a safe way to operate and control; Improper operation may cause serious personal injury or property damage.
2. This product is suitable for people who have experience in operating model aircraft and are no less than 14 years old.
3. In case of problems with use, operation, maintenance, etc. Please contact your local distributor or relevant personnel of our company.

Safety precautions

When flying a remote-controlled model aircraft, be sure to stay away from crowds. Improper assembly or damage to the body, poor electronic control, and unfamiliarity with operation can all lead to unpredictable accidents such as aircraft damage or personal injury. Please be sure to pay attention to flight safety and be aware of any external responsibilities caused by your own negligence.

1. Stay away from obstacles and crowds

Remote controlled aerial vehicles have uncertain flight speeds and states, posing potential hazards. They must stay away from crowds, high-rise buildings, high-voltage power lines, and avoid flying in adverse weather conditions such as wind, rain, and lightning to ensure the safety of pilots/surrounding populations and property.

2. Stay away from humid environments

The interior of the aircraft is composed of many precision electronic components and mechanical parts, so it is necessary to prevent moisture or moisture from entering the aircraft body to avoid accidents caused by mechanical and electronic component failures.

3. To use this product correctly, please use Genuine World Series parts for maintenance to ensure flight safety.

Please operate and use the product within the scope allowed by its functions, and it must not be used for other illegal purposes outside of safety regulations.

4. Avoid operating alone

Remote control aircraft control skills have certain difficulties in the early stages of learning, and it is necessary to avoid flying alone as much as possible, and experienced personnel are required to guide.

5. Safe operation

Please operate the remote-controlled aircraft based on your own state and flight skills. Fatigue, poor mental state, or improper operation will increase the probability of unexpected risks.

6. Stay away from high-speed rotating parts

When the rotor of the aircraft is rotating at high speed, please keep pilots, surrounding people, and objects away from the rotating parts to avoid danger and damage.

7. Keep away from heat sources

Remote control aircraft are composed of materials such as metal, fiber, plastic, electronic components, etc. Therefore, it is necessary to try to stay away from heat sources, prevent sunlight, and avoid deformation or even damage caused by high temperatures.

Warning

1. The packaging and instructions contain important information and should be retained.
2. It is your responsibility to ensure that this aircraft does not cause harm to the personal and property of others.
3. The debugging and installation of the aircraft must strictly follow the operation manual, and pay attention to maintaining a safe distance of 2 meters away from the user or others during the flight of the aircraft to avoid colliding with people's heads, faces, and bodies during flight and landing, which may cause injury.
4. Our company and the seller shall not be responsible for any loss, damage, or bodily injury caused by improper use or operation.
5. Children should be guided by adults when operating aircraft. This product is prohibited for children under the age of 14 to operate.
6. Please follow the instructions or packaging instructions for proper installation and use. Some parts should be assembled by adults.
7. The product contains small parts, please place them out of reach of children to prevent the risk of accidental ingestion or suffocation.
8. It is strictly prohibited to play on the road or in areas with accumulated water to avoid accidents.
9. Please pack the packaging materials in a timely manner to avoid harm to children.
10. Do not disassemble or modify the aircraft, as disassembly or modification may cause the aircraft to malfunction.
11. The charger battery box battery needs to be inserted into a designated power source that matches the product logo.
12. The remote control uses a 3.7V built-in lithium battery, which does not require replacement.
13. Regularly check if the charging line components are damaged, and stop using them if any damage is found until they are completely repaired before use.
14. When charging the rechargeable battery, it must be supervised by an adult. When charging, it must be kept away from high temperatures and flammable materials. When charging, the guardian should not leave the aircraft model outside the monitoring range.
15. Please do not short-circuit or squeeze the battery to avoid explosion.
16. Do not mix different types of lithium batteries.
17. The aircraft uses a 7.6V intelligent lithium battery. Take it out of the plane and charge it.
18. Do not short-circuit, disassemble, or throw the battery into fire; Do not place the battery in a hot or heated area (such as in a fire or near an electric heating device).
19. Battery Safety Instructions: Exhausted batteries should be removed from the model.
20. The power terminal should not be short circuited.
21. During flight, please stay away from other electrical equipment and use in environments with magnetism and magnetic fields, as it may interfere with the magnetic sensors in the aircraft.
22. Please maintain a safe distance from the high-speed rotating propeller to avoid the risk of twisting or cutting.
23. The motor is a heating component, please do not touch it when it has just stopped working to avoid burns.
24. Light emitting diode laser radiation, keep your eyes away from the beam.
25. Do not use the model close to the ear! Misuse may cause hearing damage.
26. Charging line: 5V \equiv 1-2A.
27. To ensure the magnetic environment requirements of aviation radio stations. During the period when relevant national departments issue radio control orders and within the region, the use of model remote controls should be stopped as required.

Safe Flight Guidelines

Requirements for image transmission site: The remote control antenna is deployed, and in an open area with no obstacles around it, the distance for image transmission is 2 kilometers. Please do not turn back against the wind.

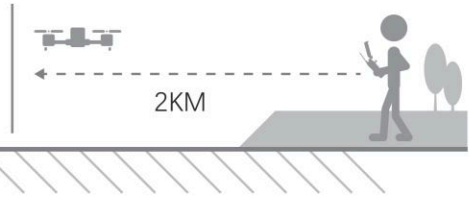

+



+



+



Flying in an open area

Strong GPS signal

Keep the aircraft
in line of sight

Flight relative altitude
 ≤ 120 meters

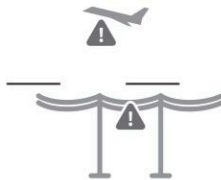

Avoid flying over or near people, trees, high-voltage power lines, buildings, airports or water areas, as well as high-strength power lines or base stations, as they may affect the compass carried on the aircraft.

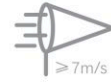

Do not use this product under adverse weather conditions such as rain, snow, fog, and wind speeds exceeding 7m/s or 16mph.

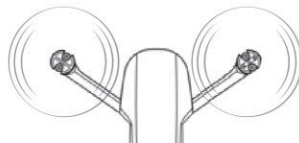

no-fly zone

Stay away from rotating propellers and motors



Understanding safety guidelines is crucial for safe flight. Before flying, please read the safety instructions carefully.

Remote control function

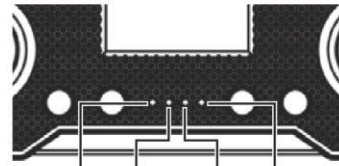
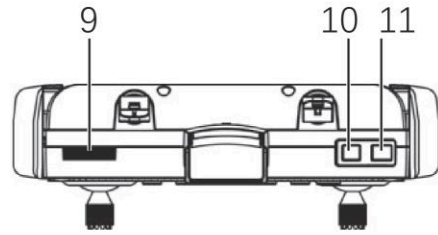
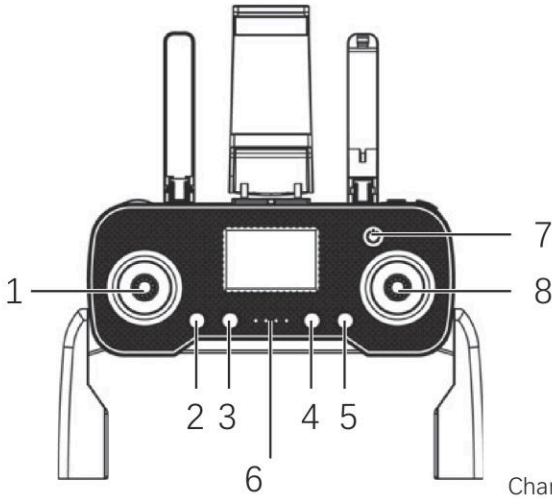

Charging indicator light Power indicator light
GPS indicator light Return indicator light

[1] Accelerator lever - up and down/left and right rotation



[2] GPS switch



[3] Short press headless mode/long press one key to take off or land



[4] Short press gyroscope/long press geomagnetic calibration



[5] One click return

[6] Indicator light



[7] Power switch

[8] Direction control lever - front and rear/left and right

[9] (Roller) Camera angle adjustment



[10] Short press to take photos/long press to record



[11] Speed switching/

Long press the obstacle avoidance function switch to switch (the obstacle avoidance function is turned off by default)

Reminder:

When the remote control is at low power, the remote control battery icon flashes. At this point, please stop flying as soon as possible and charge the remote control.

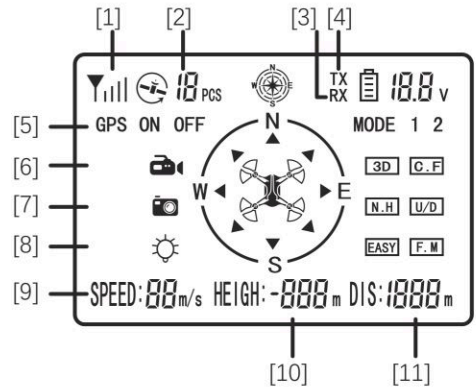

[1] GPS signal

[2] Number of GPS satellites

[3] Aircraft battery level

[4] Remote control battery level

[5] GPS switch

[6] Video recording

[7] Take photos

[8] Lighting

[9] Flight speed

[10] Flight altitude

[11] Flight distance

Aircraft components



1. 3-axis pan head
2. Propeller
3. Motor
4. LED lights
5. Intelligent lithium battery

Attention: Please remove the protective cover from the camera before starting the aircraft.

1. First press the protective cover down.
2. Then remove the protective cover in the direction of the arrow as shown in the figure. B

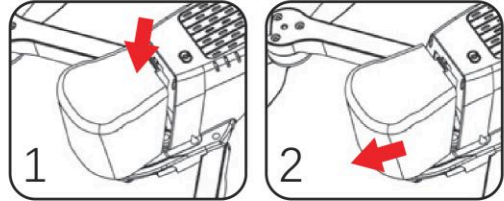

Propeller installation

Please ensure that all propellers are installed in the correct orientation as shown in the figure below.

If installed incorrectly, the aircraft will not be able to fly normally. (Fan blades are distinguished by A/B)

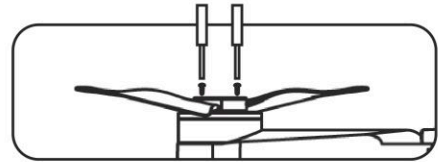

Battery installation/removal

Install the battery: Insert the battery into the aircraft battery compartment in the direction shown in the following figure (arrow 3). After installation, please check to ensure that the battery is installed in place.

Battery removal: Press the battery clip (arrow 1) and then remove the battery in the direction of (arrow 2).

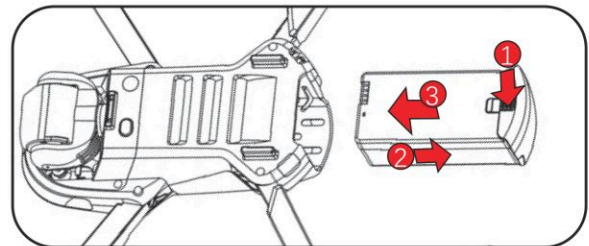

Aircraft battery and remote control charging

Connect the battery to the 5V 1-2A charging adapter using a USB charging cable, and charge the battery after connecting it. When charging the battery, the battery indicator light remains on for a long time. After the battery is fully charged, the battery indicator light goes out, and the charging time is about 4 hours.

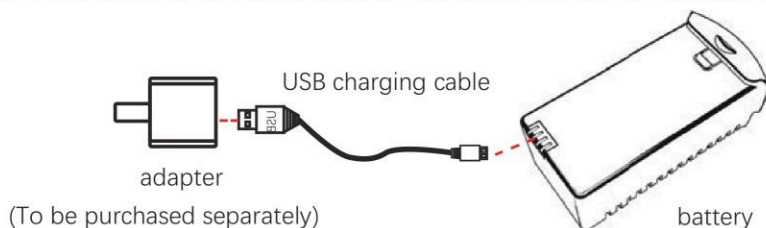

Please try to use an adapter with a charging current of 2A to charge, which can improve the charging speed.

When charging, the charging indicator light is red and the fully charged red light is off

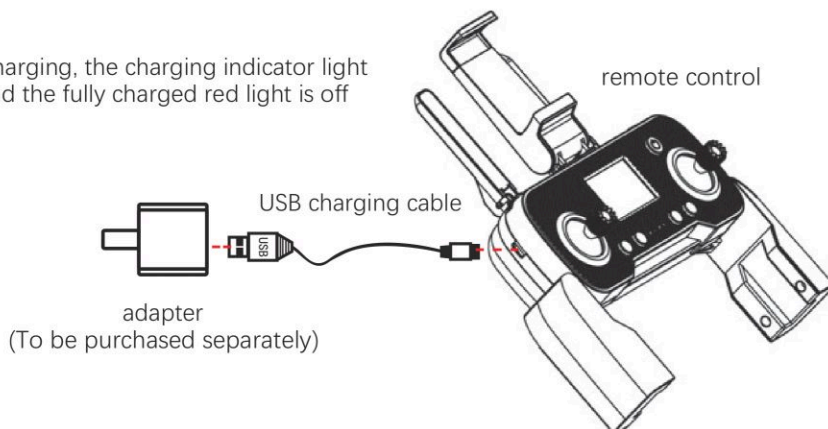

tip:



- Please insert the plug in the correct way.
- It is recommended to use a 5V 1-2A adapter for charging.
- When charging a rechargeable battery, do not use it alone for children. It must be carried out under adult supervision and kept away from flammable substances. Do not place the battery in a hot or heated area (such as in a fire or near an electric heating device).
- Please do not short-circuit or squeeze the battery to avoid explosion
- After flight, the battery needs to be charged and stored. If not in use, it is recommended to charge the battery at least once every 3 months to avoid excessive discharge and permanent damage to the battery.

Precautions during charging:

- ※ Precautions during charging:
- ※ Do not place charged batteries in high temperature and heated areas, such as open flames or electric heating devices, as damage or explosion may occur.
- ※ Do not use batteries to strike or strike hard object surfaces.
- ※ Do not immerse the battery in water. The battery should be stored in a dry place.
- ※ Personnel must not leave during charging.
- ※ Do not disassemble the battery.

Remote control operation method

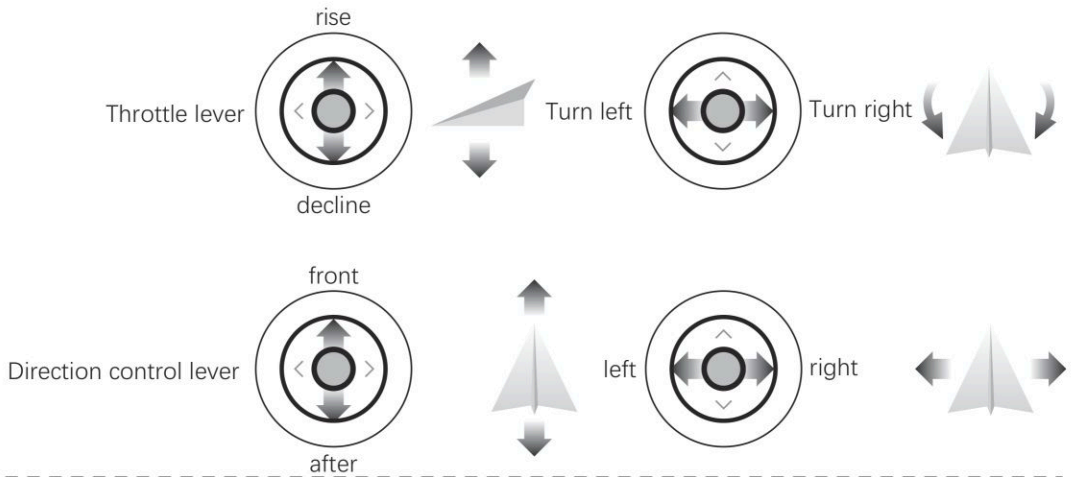

Preparation before takeoff

1. Both the remote control and drone battery must be fully charged before takeoff.
2. The drone arms and blades need to be fully extended.
3. First turn on the drone switch and then turn on the remote control switch for frequency comparison

[Step 1] Aircraft Code Matching Operation Guide



1. First, press and hold the aircraft power button for 3 seconds to turn it on, and then place it horizontally on the ground. At this time, the front and rear LED lights of the aircraft flash for self inspection.

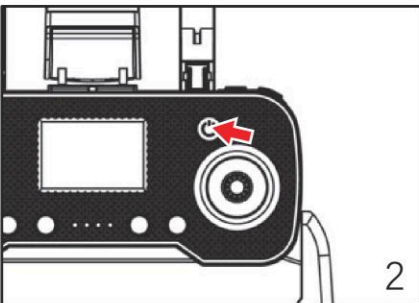

2. At the same time, when the remote control power is turned on and the code is checked, the remote control will emit a beep. At this time, the front LED light of the aircraft will become permanently on, and the rear LED light will flash, indicating successful code checking.

 The frequency alignment is successful, with the front lights permanently on and the rear lights flashing. If the front and rear lights flash simultaneously, and the remote control indicator light is also flashing, it indicates that the frequency synchronization has not been successful or the drone battery is low. It is necessary to restart the drone and re-synchronize the frequency.

[Step 2]

Gyroscope calibration

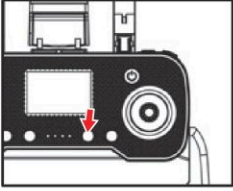

After successful frequency alignment of the aircraft, place it on a flat ground, briefly press the gyroscope calibration button, make a remote click, and the front and rear lights will flash faster, indicating successful calibration. At this point, the GPS signal can be searched, and once the light is on for a long time, the aircraft can be controlled to unlock and take off. If no GPS signal is needed, the aircraft can take off directly.

[Step 3]

Geomagnetic calibration

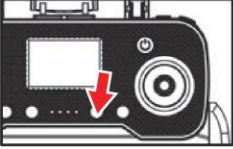

1. When flying outdoors in GPS mode, the first flight must undergo geomagnetic correction. After the aircraft successfully aligns with the frequency, press and hold the geomagnetic correction button for 2 seconds, and the remote control will beep. At this time, the aircraft's LED light will quickly flash to start geomagnetic correction.

1

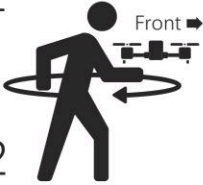

2. Lift the aircraft 1 meter above the ground, level with the ground, and rotate it three times in a clockwise direction. At this point, the remote control emits a short beep, the rear LED light remains on, and the front LED light flashes. The horizontal geomagnetic correction is completed.

2



3. Stand the aircraft upright, perpendicular to the ground, and rotate it three times in a clockwise direction. At this point, the remote control emits a long beep, and the front LED light remains on, while the rear LED light flashes, indicating successful vertical geomagnetic correction. At this point, the search GPS signal light remains on to unlock takeoff. If you do not need GPS fixed point flight, you can fly directly.

3



The geomagnetic correction must be completed simultaneously in both the horizontal and vertical directions to be considered successful. If the geomagnetic correction fails, the takeoff cannot be unlocked and the geomagnetic correction must be re-performed. After correcting the geomagnetism at the same location, there is no need to correct it every time you fly.



Do not calibrate in areas with strong magnetic fields, such as magnetic mines, parking lots, large metal structures with underground steel reinforcement, etc.

[Step 4]

CONNECT WIFI

Enable the mobile device WIFI function, select VS-GPS-BY - ***** from the WIFI list, and open the VS GPS PRO APP. Please refer to the VS GPS PRO manual for specific instructions.

[Step 5]

GPS search successful



Please ensure that the takeoff environment is open and that satellite signals greater than 10 stars are detected before takeoff. 10 

The first search for stars takes approximately 1 minute to 1 minute and 30 seconds.

[Step 6]



Throttle lever



Direction control lever

Motor unlocking

At this point, the throttle lever and direction lever are simultaneously pushed towards the lower left and right corners to complete unlocking. After the motor is started, flight can be completed.

⚠ Before unlocking, fully unfold the blades.

Mode switching

Attention: Indoor flight must switch to indoor mode. Outdoor flight must be switched to GPS mode.

1. Indoor mode. After successful code matching, the aircraft defaults to GPS mode indoors. To take off indoors, first press the GPS switch on the remote control and switch to indoor mode to unlock takeoff.

Attention: When the aircraft is in the following environment, the optical flow positioning and hovering effect of the lower lens is not good, which will lead to difficulty in stable flight of the aircraft, resulting in the phenomenon of body shaking.

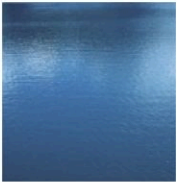

On the water surface



Dim light



Large height difference

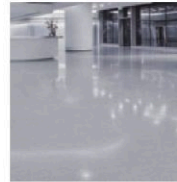

Smooth reflective ground



Bicolor stripe

2. [GPS Mode] After the aircraft successfully matches the code, in an outdoor environment, the aircraft will automatically enter the search mode. When searching for stars, the aircraft will be placed in an open area without obstacles such as tall buildings or wires. When the number of satellites reaches about 6, the positioning will be completed. The remote control will beep to indicate entering GPS mode, and the arm light will be on for a long time to unlock and take off.

Product Function Analysis

A. One click takeoff/landing

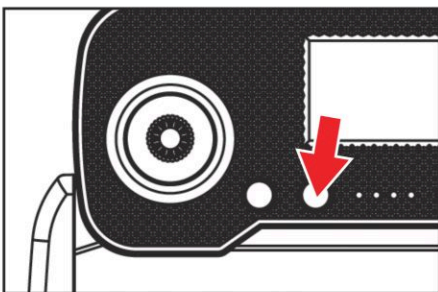

● After unlocking the aircraft, press and hold the button for 2 seconds, and the aircraft will automatically take off and hover at an altitude of about 1.5 meters.

● During flight, press and hold the button for 2 seconds, and the aircraft will automatically land on the ground.

B.headless mode

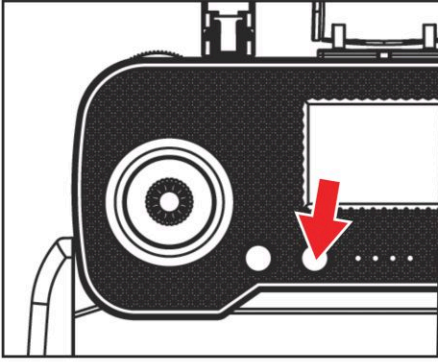

Press the headless mode button, and the remote control emits a "drdi" sound. When the aircraft is unlocked, the direction indicated by the nose is the front of the flight. During the flight, rotate the aircraft in the right direction, and the front of the flight is still the direction indicated by the nose when the aircraft is unlocked.

C.Return flight

The aircraft has a return function. If the return point is successfully recorded before takeoff, the communication signal between the remote control and the aircraft will be lost or the return button will be pressed. The aircraft will automatically return to the return point and land to prevent accidents. There are three different ways for aircraft to return:

1. One click return 2. No signal return 3. Low battery return.

Precautions for returning:

- During the automatic return process, the aircraft is unable to avoid obstacles.
- When the GPS signal is poor or GPS is not working, it is not possible to return.

Return point:

During takeoff or flight, when GPS receives more than 10 stars for the first time, it will be recorded as the current position of the aircraft as the return point.

1.One click return

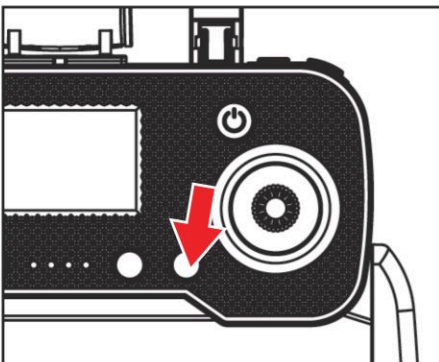

When the GPS signal is good (the number of satellites is greater than 10), the aircraft can be launched to return by pressing the button in the figure below on the remote control. The return process is the same as that of a lost connection return, but the difference is that when the aircraft returns to land, the user can control the aircraft through the joystick to avoid obstacles. The return button can exit the return, and the user can control the drone flight again.

2.No signal return

The GPS signal is good (the number of GPS satellites is greater than 6), the compass is working normally, and the aircraft has successfully recorded the return point. If the remote control signal is interrupted, the drone will automatically return to the signal location and then connect to the remote control.

3.Low power return

After the low pressure of the aircraft, the indicator light will slowly flash, and the remote control will emit a continuous warning sound of "dripping". At this time, the aircraft will automatically return to the takeoff point 30 meters away. (After low power, the aircraft will return to the vicinity of the takeoff point, and the altitude and distance of the aircraft will be limited to within 30 meters.)



Kind reminder: The aircraft is in a low power return state, and the remote control cannot cancel the return.

D.Photography/Video Recording

Short press the remote control photo and video button, and the mobile app will display a progress bar for photo archiving.

Press and hold the remote control camera and video button for 2 seconds, and the mobile app will display the recording time and save it.

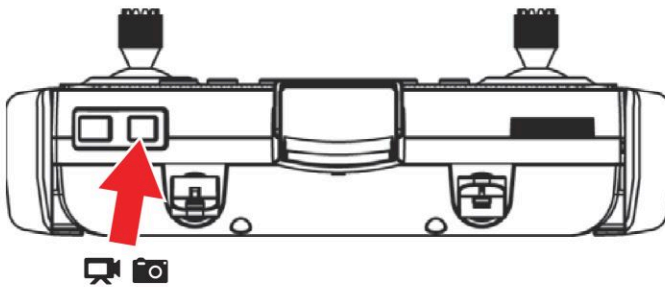

Short press to take photos/long press to take photos for 2 seconds

Camera angle control

By pressing the scroll wheel button on the remote control, the shooting angle of the pan tilt camera can be adjusted (as shown in the picture)

